

Technical specification

1 Seat - metal frame filled with foam, density of 55 kg/m³, upholstered

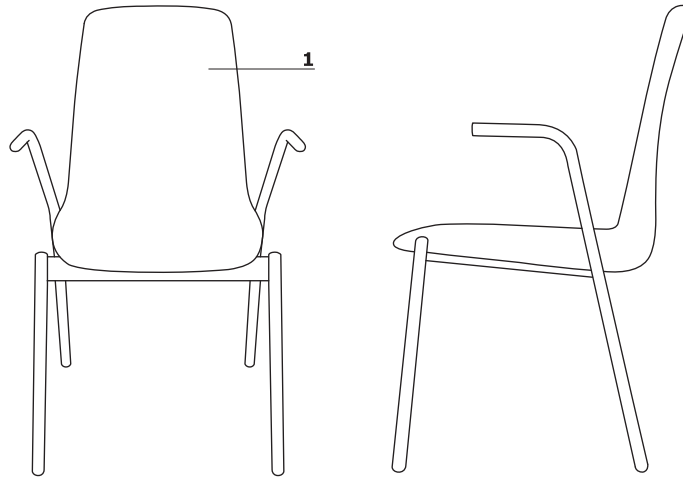

- max. load 120 kg

Dimensions (mm)

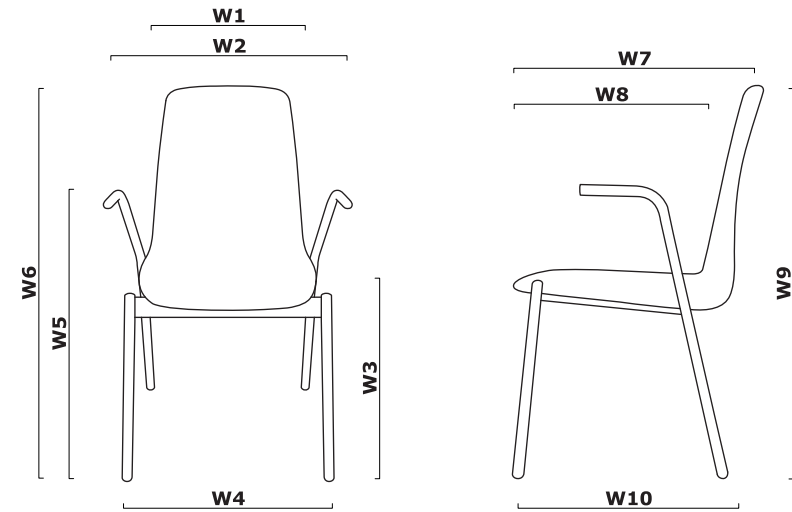

W1 - 350 | W2 - 450 | W3 - 490 | W4 - 450 | W5 - 640 | W6 - 900 | W7 - 570 | W8 - 500 | W9 - 900 | W10 - 450|

Bases

1 Base P7KM:

- 4 - star, metal, powder coated
- fixed seat
- legs 30 × 18 mm, wall thickness 1,5 mm; CNC - bent
- castors for soft floors

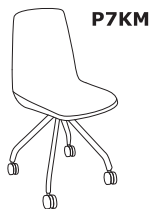

2 Base P7KT:

- 4 - star, metal, powder coated
- fixed seat
- legs 30 × 18 mm, wall thickness 1,5 mm; CNC - bent
- castors for hard floors

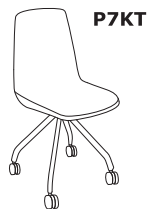

3 Base P7:

- 4 - star, metal, powder coated
- swivel seat - 360°
- legs 30 × 18 mm, wall thickness 1,5 mm; CNC - bent
- legs finished with polypropylene feet, colour: black



4 Base P1:

- 4 - legged, metal, powder coated
- legs made of tube Ø22 mm, wall thickness 2,5 mm, CNC - bent
- legs finished with polypropylene feet, colour: black



5 Base P2:

- 4 - legged, metal armrests, powder coated
- legs made of tube Ø22 mm, wall thickness 2,5 mm, CNC - bent
- legs finished with polypropylene feet, colour: black



6 Base P3KM:



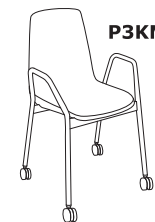



- 4 - legged, metal armrests, powder coated
- legs made of tube Ø22 mm, wall thickness 2,5 mm, CNC - bent
- castors for soft floors

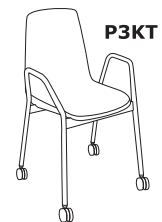

7 Base P3KT:

- 4 - legged, metal armrests, powder coated
- legs made of tube Ø22 mm, wall thickness 2,5 mm, CNC - bent
- castors for hard floors



Symbol: ULTIK					
	Base	II	III	kg m3 pcs	Additional information
		Medley, Atlantic, Vita, River	Xtreme, Synergy		
	P7KM			12 0,255 1	
	P7KT			12 0,255 1	
	P7			12 0,255 1	
	P1			12 0,255 1	
	P2			12 0,255 1	
	P3KM			12 0,255 1	
	P3KT			12 0,255 1	

Technical specification

1 Seat - metal frame filled with foam, density of 55 kg/m³, upholstered

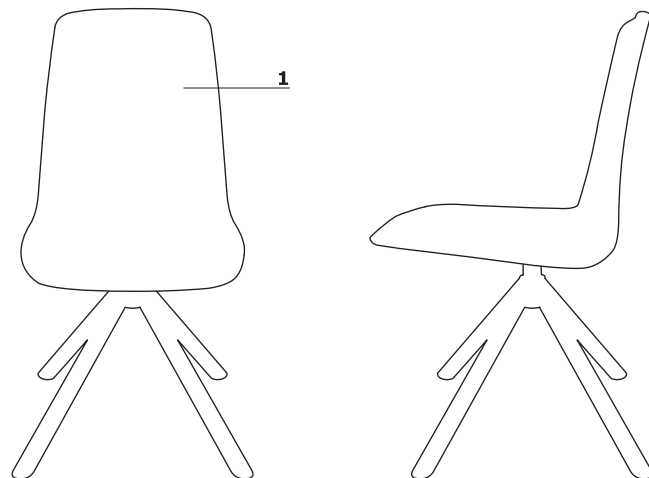

- max. load 120 kg

Bases

1 Base P8:

- 4 wooden legs, Ø35 mm
- beechwood coated with transparent varnish
- metal legs - connecting elements, colour: black semi-matt

2 Base P9:



- 4 - star, wooden, Ø35 mm
- beechwood coated with transparent varnish
- swivel seat - 360°
- metal legs - connecting elements, colour: black semi-matt

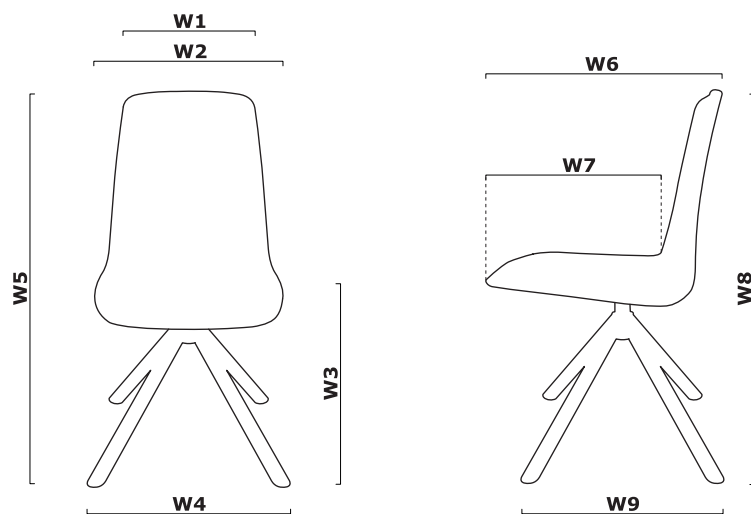

Dimensions (mm)



W1 - 340 | W2 - 430 | W3 - 440 | W4 - 475 | W5 - 860 | W6 - 580 | W7 - 420 | W8 - 860 | W9 - 475|

Symbol: ULTIKW					
	Base	II	III	kg m3 pcs	Additional information
		Medley, Atlantic, Vita, River	Xtreme, Synergy		
	P8			10 0,255 1	
	P9			10 0,255 1	